



# THE POLISHED SLAB

SOUTHERN NEVADA GEM AND MINERAL SOCIETY



April 2023

A NEWSLETTER FOR ROCKHOUNDS SINCE 1940

VOLUME 83 ISSUE 4

## UPCOMING MEETINGS

**Apr. 27, 2023 - Board Mtg**  
**May 1, 2023 - General Mtg**

### SNGMS Contacts:

www.sngms.org  
sngmsnews@gmail.com  
sngmspresident@gmail.com  
sngmsvicepresident@gmail.com  
sngmssecretary@gmail.com  
sngmstreasurer@gmail.com  
sngmsshowchair@gmail.com  
sngmspublicity@gmail.com  
sngmsjamboreeshowchair@gmail.com

Hello -

Spring has finally arrived, I think! A great time to get out and enjoy the wildflowers and rockhound your favorite spot before our heat arrives.

Our meeting had a few changes this month. We are now limiting Presentations and Proposals to 25 min with 20 min allowed for discussion after the speaker has finished. It seemed to help the flow and many people were able to voice their thoughts and opinions. We are also addressing Business first, with club announcements later in the program. Ron Mazz suggested we have our Raffle during the Break and we tried it out. It worked very well! We were finished and out by 7:45 PM. Thanks to everyone for helping to keep the meeting short and on track.

If you missed the meeting, we voted on several important issues. Dale Bright and Orville Wiemers gave a final presentation on the proposed 2023 Viva Las Vegas Rocks show. Their proposed budget showed a profit and they answered many questions from the members. The vote was in favor of having the show. It is scheduled for Nov 3-4-5 at the Santa Fe Casino and Hotel. If you are interested in being a vendor, please contact Diane Burgess at DianeBurgess@cox.net. There is a lot of curiosity already with over 40 vendors expressing an interest in signing up. The contract is being finalized and should be available soon. Committees are forming and volunteers are needed so please contact Orville at sngmsvicepresident@gmail.com. Dale Bright volunteered to be the Show Chairman and you can contact him at DaleRBright@gmail.com with questions.

Lloyd Chayette will be getting in T-shirts shortly featuring the winning design voted on at the meeting. We had some very talented entries. He's hoping to have the shirts available for sale in time for the Jamboree.

Chops Wenzl presented a delicious menu from the Sunset Station for our Christmas party. He also took a vote on having the party there or having a potluck. The casino won the vote by a large margin. Mark your calendars for Sunday December 3, 2023, at 4 pm. Tickets will be available soon.

Congrats go to Sara (Schiller) Tredwell who married Jonathan Tredwell in March but still has found time to organize volunteers for the Jamboree Show coming up in Boulder City on May 5-7. If you can fit 4 hours or more into your calendar, she is scheduling volunteers at SNGMSjam@gmail.com.

Please take a moment to review the newsletter for more exciting details on all our great classes, the Kids Club adventures, rockhounding trips, and interesting speakers coming up! And remember you could win shop time coupons for your winning Cabochon – this month's fun theme is Lobster!

See you in the rocks!

Andrea Packo  
SNGMS President

### Inside This Issue

<b>Field Trips &amp; Events</b>	<b>2</b>
<b>Board Meeting Minutes</b>	<b>3</b>
<b>General Meeting Minutes</b>	<b>4</b>
<b>Sunshine Report, Birthstones, &amp; Puzzle</b>	<b>5</b>
<b>Meeting Dates, Shop Hours, &amp; Maps</b>	<b>6</b>
<b>Studio Tips &amp; Tricks</b>	<b>7</b>
<b>Cabochon &amp; T-Shirt Contests</b>	<b>8</b>
<b>Mining Claim</b>	<b>9</b>
<b>Birthdays, New Members Welcome, Jamboree Info</b>	<b>10</b>
<b>Kids Club Activities</b>	<b>11</b>
<b>SNGMS Volunteer Staff</b>	<b>12</b>
<b>Speakers &amp; Sponsors</b>	<b>13</b>
<b>Mineral Musings</b>	<b>14</b>
<b>Class Schedules</b>	<b>15</b>
<b>Polished Slab Advertising Rates</b>	<b>16</b>



2023 Field Trips<sup>1</sup> & Events

Field Trip <sup>1</sup> /Event	Date	Location
Variscite/Turquoise Pay to Dig <sup>6</sup>	8 am Sunday, April 16, 2023 – Easter Blue Mine. Monday, 8 am April 17, 2023 – Broken Arrow Mine.	Tonopah, NV. \$100 fee/day. Meet at Tonopah RV Park just past Radar Road on the right side of US 95
Sandy Valley Earth Day ( <b>bring lunch, Mary Beth Paladino speaks 12:15 pm</b> )	April 22, 2023 Noon - 4:00 pm	Sandy Valley Senior Center, 695 W Quartz Ave, Sandy Valley NV 89019
Eldorado Canyon Gold Mine Tour, Gold Panning & Prospecting Merit Badge 12.5 & 12.6 <sup>5</sup> – <b>RSVP required by April 22, Limited to 40 people</b>	April 29, 2023 9:20 am – 2 pm	16880 NV-165, Nelson, NV 89046
SNGMS Gem & Mineral Show <sup>4</sup>	May 6, 2023, 9 am –5 pm May 7, 2023 9 am – 4 pm	Parks & Recreation Gym 900 Arizona St., Boulder City, NV
Spring Jamboree <sup>4</sup>	May 6 -7, 2023, 9 am – 4 pm	Bicentennial Park, Boulder City, NV
Agate and Chalcedony Trip <sup>1</sup>	May 8, 2023	Bitter Springs, NV
May 20 Ore Car Mine Field Trip, Gold Panning & Prospecting Merit Badge 12.7 & BBQ <sup>5</sup> - <b>RSVP required by May 12</b>	May 20, 2023	SNGMS Ore Car Mining Claim, Mile Marker 16 off of North Shore Road at Lake Mead National Recreation Area
JOGS Las Vegas Gem & Jewelry Show	May 29 – June 1, 2023	Mirage Events Center, 3400 Las Vegas Blvd S, Las Vegas, NV 89109
Agate and Jasper Trip <sup>1</sup>	June 10-11, 2023	South Cadys, CA
Rocky Mountain Federation Of Mineralogical Societies <sup>2</sup>	July 13 – 16, 2023	Ramkota Hotel, 800 N Poplar, Casper, WY
Agate and Jasper Trip <sup>1</sup>	August 12-13, 2023	Utah – Holt Canyon &/or Milford
Tonopah Rock and Bottle Show <sup>3</sup>	August 4 – 6, 2023	Tonopah, NV
JOGS Tucson Gem & Jewelry Show	August 31 – September 3, 2023	Tucson Expo Center, 3750 E Irvington Rd, Tucson, AZ 85714
Purple Agate Trip <sup>1</sup>	September 23 - 24, 2023	Burro Creek, AZ
Variscite/Turquoise Pay to Dig <sup>1</sup>	October, 2023 – exact date TBD	Tonopah, NV or Kokoweef, CA

- 1) Field trip destinations, dates, and times are subject to change. Contact Joel Coombs [joel.coombs@bldr.com](mailto:joel.coombs@bldr.com)
- 2) Contact Mac Goss [macogre13@gmail.com](mailto:macogre13@gmail.com)
- 3) Classes and vendor booths available, contact Chrissy Pope, 775-277-0840 [chrissy.townoftonopah@gmail.com](mailto:chrissy.townoftonopah@gmail.com)
- 4) Free admission. Contact [sngmsjam@gmail.com](mailto:sngmsjam@gmail.com) for vendor and volunteer information
- 5) MUST RSVP to Wendy Dresser at 702-556-2748 (text or call)
- 6) Contact Del Walkenshaw 702-451-8040 ext 4, [desertartsupply@aol.com](mailto:desertartsupply@aol.com)

## Some links with information about shows and exhibits that you may find helpful:

American Federation Of Mineralogical Societies – [www.amfed.org](http://www.amfed.org)

Rocky Mountain Federation of Mineralogical Societies – [www.rmfm.org](http://www.rmfm.org)

Rock & Gem Magazine website – [www.rockngem.com](http://www.rockngem.com)

**Parking Lot Sale, March 11, 2023**  
Photo Courtesy of Dave Ford



**Dave Ford, Grill Master**  
**Rock Swap April 2, 2023**



**Family at**  
**Rock Swap April 2, 2023**



## SNGMS Board Meeting Minutes, March 30, 2023

The meeting was held at the SNGMS Lapidary Shop starting at 6 pm. Board members attending were: Andrea Packo, President; Orville Wiemers, Vice President; Peggy Sue Moore, Treasurer; Bob Belcher, 3 year Board; Del Walkenshaw, 2 year Board; Ron Mazz, 1 year Board; Lloyd Chayette, 1 year Board/Past President; Jack Toogood, Parliamentarian. Lorrilee Stackhouse, Secretary, absent due to medical reasons.

The Pledge of Allegiance was recited. Minutes of the previous board meeting were read by Peggy Sue Moore, Treasurer and acting Secretary. The minutes were approved as read.

**Treasurer's report:** Ending balance in checking account is \$20,431.81, showing a loss of \$1,657.92.

The SNGMS Lapidary Shop rent has increased to \$1,708.00/month due to CAM charges. The annual audit has been set up with member volunteers

**Unfinished business:** Discussed locker rentals at the SNGMS Lapidary Shop, selling donated items on Etsy, T-Shirt contest, and current membership of 551 paid members. An email will be sent out as a reminder for members to renew.

**Spring Jamboree update:** Geodes are needed. Items are needed for Silent Auction at the Jamboree show.

**Kid's Club:** Refer to the calendar of events. The May 20<sup>th</sup> meeting topic will be Metal Detecting. The Kids Club committee is looking for metal detecting members to help.

**Upcoming events:** refer to the calendar of events

**Awards Banquet:** A vote for a Catered or Pot Luck banquet will be held at the General Membership meeting.

**Future Classes:** refer to the calendar of events.

**Field Trips:** The next trip will be to Tonopah, Nevada. Refer to Events Calendar for dates and contact Del Walkenshaw at Desert Art Supply to sign up.

**Future speakers:** There will be no speaker for the April General Meeting.

**New Business:** A motion to purchase a new Oxy/Acetylene compressed gas system, not to exceed \$1,000.00 was made by Ron Mazz and seconded by Bob Belcher. A vote was taken and the motion did not pass.

**Meeting Adjourned** at 7:45pm.



## SNGMS General Meeting Minutes, April 3, 2023

The General Membership meeting convened at 6:00 pm. The Pledge of Allegiance was recited. The minutes of the previous meeting were read by Peggy Sue Moore, substituting for Lorrilee Stackhouse, Secretary. The minutes were approved as read.

**Treasurer's Report:** After the most recent deposit, the March closing checking account balance is: \$21,022.76. March ended with a net loss of \$1,066.97. Investments are unchanged.

**Unfinished business:** The presentation for Viva Las Vegas Rocks Show, proposed for November 3, 2023, was continued since it was cut short at the March 2023 General Meeting due to time constraints. Since a WIFI connection was not available, a graphic display was not available. Orville Wiemers stated that the show budget would not exceed \$27,000.00, with \$21,325.00 going to Santa Fe Station, and a \$3,000.00 advertising budget as part of the overall budget of \$27,000.00. The projected income is \$34,000.00. A motion to approve this show and budget was made by Bruce Martin and seconded by Lloyd Chayette. A lengthy discussion ensued by members both for and against continued for approximately 20 minutes. A vote was held with 46 for and 29 against. The motion passed.

**New Business:** Chops Wenzl gave a presentation showing a proposed dinner menu with the Sunset Station Casino for the Annual Awards Banquet, to be held in December 2023. A motion was made to vote between having a PotLuck Dinner or a Catered dinner by Chops Wenzl and seconded by Lloyd Chayette. The vote was overwhelmingly in favor of the catered banquet. A second motion was made to accept the Sunset Station proposal and pay the \$1,000.00 deposit to lock in a date with Sunset Station catering department. Member's tickets will be \$30.00 and non-member's tickets will be \$60.00. Tickets will go on sale in the Fall.

**The Raffle/Drawing** was held during the break.

**Spring Jamboree:** Volunteers are still needed. We have less than one month before this event. We still need donations for the Silent Auction fund raiser held during the Spring Jamboree.

**Cabochon Contest:** The theme for this month's contest was Jelly Fish. First place went to Bruce Martin and Second place went to Ron Mazz.

**T-shirt Design Contest:** The T-shirt design contest was held and the winning design was submitted by Kendra White. 100 T-Shirts will be printed up for sale at the Spring Jamboree. The price will be \$20/shirt as a fund raising project for the Club.

**Membership report:** There are 551 paid members.

**Kid's Club report:** The Gold Prospecting badge will be the subject in May. An email will be sent out with the details. The Kids Club committee is looking for members with metal detectors to help.

**Sunshine report:** Beth Jones gave the Sunshine report. See page 5 for details.

**Field Trip report:** An email will be sent out by Del Walkenshaw for the Tonopah trip this month. This is a pay-to-dig trip and spots are available.

**May Speaker:** The speaker at the May 2023 General Meeting will be John Fish. He will discuss lapidary arts and gemology.

The meeting was adjourned at 7:40 pm



# Sunshine Report

from Beth Jones

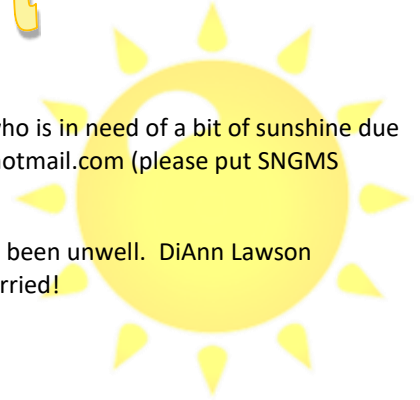

If you hear of any SNGMS member with an event to celebrate (wedding, anniversary, etc.) or who is in need of a bit of sunshine due to accident, illness, etc., PLEASE call Beth Jones at 702-505-5819 or email her at punkyjones@hotmail.com (please put SNGMS Sunshine in the Subject).

Lorilee Stackhouse has been ill. Amber Palecek is not feeling well. JoAnn and Mik Sprott have been unwell. DiAnn Lawson participated in a marathon, finishing in less than 2 hours! Johnathon and Sara Tredwell got married!

## Hidden Gems Crossword

(answers on page 9)

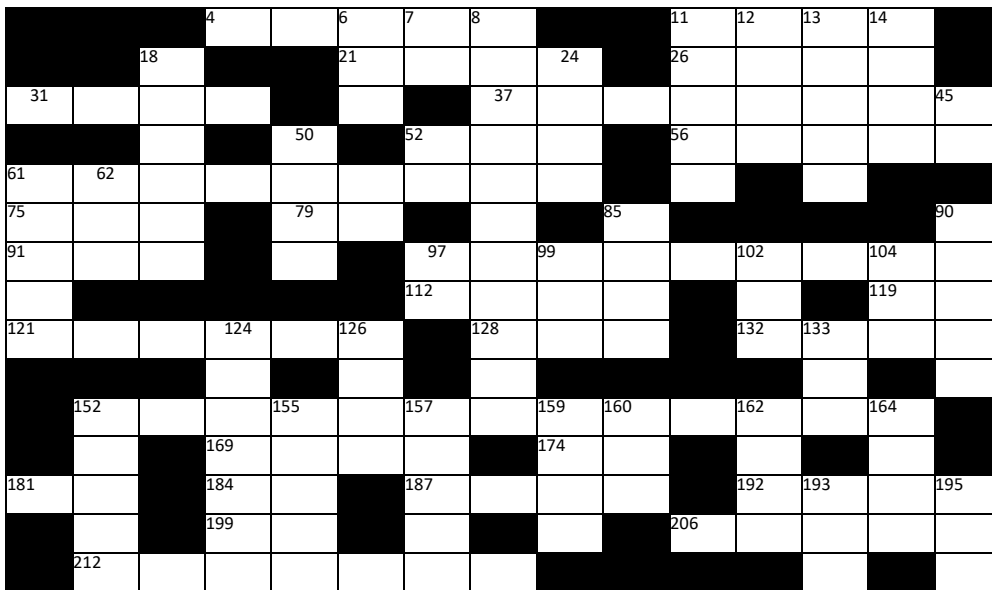

- 18. Hexagonal crystals of silica
- 24. Sounds like gneiss
- 45. Half of a laugh
- 50. Red or pink corundum
- 52. Hawaiian leaf used in leis
- 61. November birthstone
- 62. Neighbor of Saudi Arabia, abbr.
- 66. One of a team that pulls wagons
- 85. Green stone highly prized in Asia
- 90. Aquamarine is a variety of this mineral
- 97. Perhaps a baby's first word
- 99. French for "the"
- 102. Possessed
- 104. Hill or rocky peak
- 124. Yellow variety of quartz
- 126. Tack
- 133. Hawaiian fish
- 152. Tectonic \_\_\_\_
- 155. Gossip
- 157. Wild
- 159. Dutch cheese
- 160. It holds back water
- 162. Chalcedony with parallel banding
- 164. It's a \_\_\_\_
- 193. German for "one"
- 195. Egg layer

**Across**

- 4. Found in a mollusk
- 11. Gee whiz
- 21. Neighbor of Iraq
- 26. Jazzy Fitzgerald
- 31. Watery blue
- 37. Stone that looks like pine nuts
- 52. A nervous \_\_\_\_
- 56. Russian vacation home
- 61. SNGMS gemstone
- 75. Breakfast grain
- 79. Base Exchange, abbr.
- 91. Candy dispenser
- 97. Green stone with black swirls
- 112. Arizona Education Department, abbr.
- 119. Either \_\_\_\_
- 121. The densest gemstone
- 128. Employ

- 132. Small boat
- 152. Fossilized trees
- 169. The \_\_\_\_ of law
- 174. Russian for "yes"
- 181. Sharp Hawaiian lava
- 184. I am, contraction
- 187. How rock hounds search
- 192. Yes, slangily
- 199. Negative
- 206. Drive out
- 212. Green stone that's mined or manufactured

**Down**

- 6. Help
- 7. Railroad, abbr.
- 8. Blue stone with pyrite inclusions
- 11. Stone with crystal lined cavity
- 13. A rock prepped for making cabs
- 14. Old English word for "have"

**Diamond, the April Birthstone**

The name "diamond" means invincible or unbreakable. The color depends on the impurities in the stone. Diamonds are mined around the world. Africa is the major producer of rough diamonds. Russia is a top producer by both quantity and value. Diamond mining has boomed in Australia since 1983, and deposits were discovered in northern Canada in the 1990s. Diamond is 10 on the Mohs scale.



**SNGMS Meeting Schedules and Lapidary Shop Hours**

SNGMS 2023 Meeting Schedule	
Board Mtg	General Mtg
27-Apr	1-May
1-Jun	5-Jun
6-Jul	10-Jul
3-Aug	7-Aug
7-Sep	11-Sep
28-Sep	2-Oct
2-Nov	6-Nov
30-Nov	none
<b>Awards Banquet</b> Dec-03	

**SNGMS General Meeting**  
*Non-members welcome!*

1st Monday of every month (2nd Monday if a holiday falls on the first Monday). No meeting in December.

We meet at:  
Eagles Lodge  
1601 E Washington Ave.  
Las Vegas, NV 89101

Show & Sell 5-6 PM  
General Meeting 6-8 PM

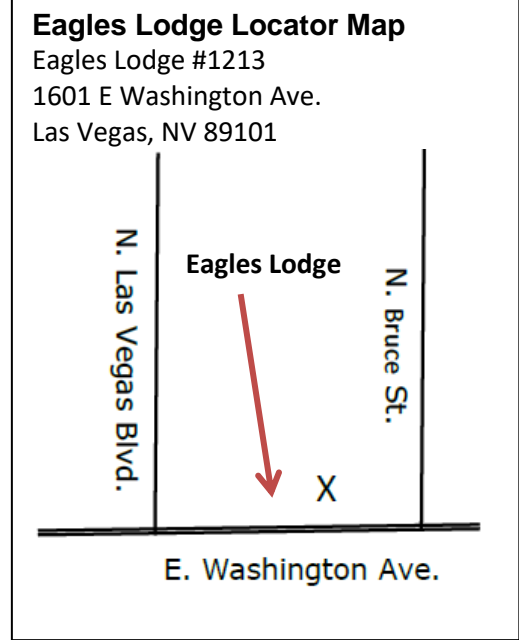

**Rock Stars Kids Club** meets the 2nd Sunday of every month (unless it falls on a holiday) from 3pm - 5pm at the SNGMS Lapidary Shop

**Location of the SNGMS Lapidary Shop**

3111 South Valley View Blvd,  
Building E Shop Suite 125  
Las Vegas, NV 89102

Please, **under no circumstances**, park in front of Unit 124 or Unit 126 (the units next to the SNGMS Shop). The owners of the units come in at odd hours and need access to their parking spaces. There is ample parking across from the SNGMS Lapidary Shop that is not in front of any unit.

**Finding the SNGMS Lapidary Shop**

Proceeding west on Desert Inn Road, take the first right past South Valley View Blvd. into the industrial park area. Drive past the building on your right, then jog right, then left and you will be in front of Building E. Another option is to enter off of Wynn Rd. Go west on Desert Inn Rd. to Wynn Rd., turn right onto Wynn Rd. and go to the first entrance on the right (past the BIG white Commercial building sign) turn right and straight in front of you is Building E, Suite #125.

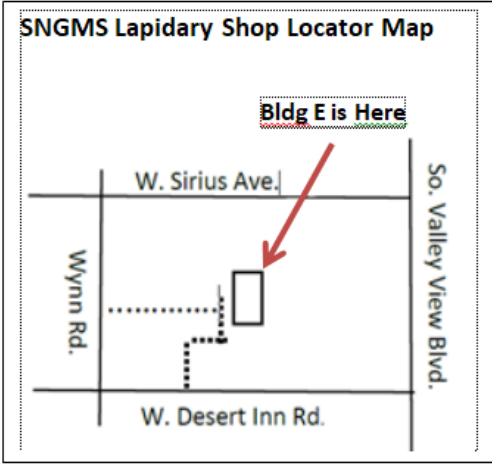

**SNGMS LAPIDARY SHOP HOURS\***

Sunday 10 am - 3 pm  
Monday Closed for general use: Various Classes  
Tuesday 10 am - 7 pm  
Wednesday 10 am - 7 pm  
Thursday 12 - 9 pm  
Friday 12 - 9 pm  
Saturday 1 - 6 pm

**SHOP EQUIPMENT FEES:**

All equipment is \$6/hour. Machines are metered, so you only pay for the time the equipment is actually running.

**SHOP CLOSED:**

Kids Club: 3- 5 pm 2nd Sunday of the Month  
Board Meeting: Various Thursday Nights 6 - about 7 pm

**\*Check Email and "Polished Slab" for possible date changes.**



Lapidary and Jewelry Studio  
Tips & Tricks

Minimize Broken Saw Blades in a Jeweler's German Saw Frame

**Check the blade tension**

The saw blade **must** be taut in the frame. Once you've loaded the blade in the frame (with teeth facing out and down), flick the blade with your fingernail. A taut saw blade will make a high pitched ping. If you hear a dull sound instead, take the saw blade out and try again. If you can't get the saw blade tight enough, adjust the length of the spring arm (make it longer) with the height adjustment knob.

**Work at the correct bench or table height**

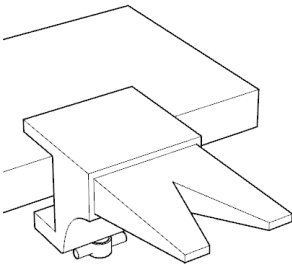

Bench Pin

Hold the metal securely so it doesn't move when you cut it with the saw, otherwise the blade will snap. The most effective way to support your work while cutting is to use a bench pin. A bench pin is a piece of wood with a "V" groove cut into it. The pin is clamped to a bench or table. The bench pin should be mounted at chest height. This keeps your arm in the proper position for maximum sawing efficiency. If you've been trying to saw hunched over, this change will make a big difference.

**Don't use a death grip on the saw handle**

Instead of tightly gripping the handle of your saw frame, try loosening your grip. Don't push hard on the blade to force it forward while you're sawing. Focus on easy, up and down VERTICAL strokes, and let the saw blade do the work.

**Turn the metal, not the saw, to change the direction of a cut**

If you turn the saw blade instead of the metal to change the direction of the cut, it's almost certain the blade will break. Turn the metal, not the saw to make a turn. Be sure to keep the blade moving up and down as you turn the metal. This is hard to learn, but it will get easier with practice!

**Lubricate the saw blade**

When you saw metal, there is friction between the saw blade and the metal. The friction makes it hard to saw. There are several types of cutting lubricants, including waxes and butters, to reduce the friction. Specialty wax for jeweler's saws is a common lubricant. Drag your saw blade once through the lubricant (after the blade is loaded in the saw frame) and you're ready to saw! Reapply the lubricant as needed throughout the sawing process to keep the saw blade moving smoothly through the metal.

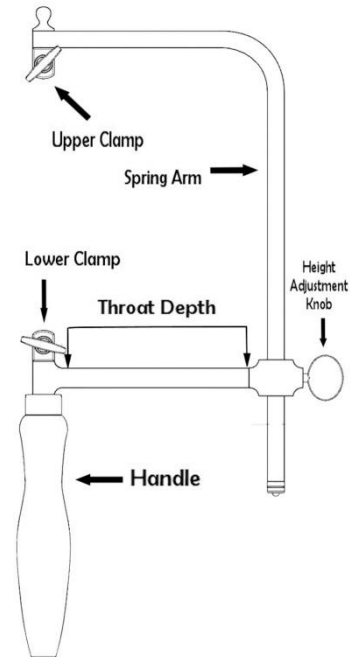

German Pattern Saw Frame

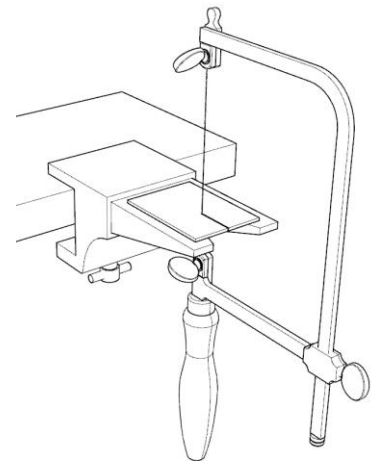

Saw Frame Held Vertically for Optimal Cutting



**2023 Cabochon Contests**

MONTH	CABOCHON THEME	CONTEST WINNER
January	Rainbow Trout	Lloyd Chayette & Bruce Martin tied
February	Lion Fish	Lloyd Chayette 1 <sup>st</sup> George Stewart 2 <sup>nd</sup>
March	Clown Fish	Lloyd Chayette 1 <sup>st</sup> Bruce Martin 2 <sup>nd</sup>
April	Jellyfish	Ron Mazz 1 <sup>st</sup> Bruce Martin 2 <sup>nd</sup>
May	Lobster	
June	Starfish	
July	Octopus	
August	Seahorse	
September	Coral	
October	Shark	
November	Whales	

The SNGMS hosts a cabochon contest at each of our monthly meetings. Bring a cab you have cut that matches that month's theme. Meeting attendees vote on their favorite cab, and the first and second places winners are announced at the meeting. The first place award is 2 hours of free shop time, and the second place winner gets 1 hour of free shop time. The May 2023 cabochon theme is "Lobster." **Good Luck!**



**Lobster**

**TO BE ELIGIBLE FOR THE CABOCHON CONTEST YOU MUST HAVE AT LEAST ONE HOUR OF PAID SHOP TIME FOR THE PRIOR MONTH.**

**April 2023 Cabochon Contest Winners**

Bruce Martin took 1st place (entry #3) and Ron Mazz won 2nd place (entry #5) in this month's cabochon contest.

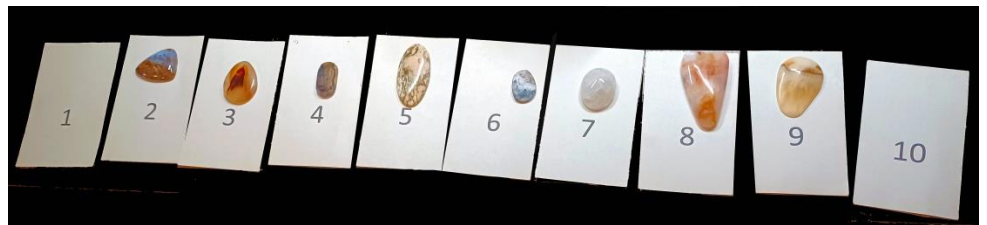

**SNGMS T-Shirt Contest**

Kendra White won the SNGMS T-Shirt Contest. One hundred shirts will be printed for sale at the 2023 Spring Jamboree in Boulder City, Nevada, May 6 -7, 2023, 9 am – 4 pm. The cost is \$20/shirt.





**SNGMS Ore Car Mining Claim Access**

Peggy Sue Moore reports that the road to the SNGMS Ore Care Mining Claim in the Lake Mead Recreation Area was recently graded. The claim is located at Mile Marker 16 off of North Shore Road. You can find agate, travertine, and fossilized algae at the claim. Be sure to wear good shoes, carry drinking water, and wear sun protection.

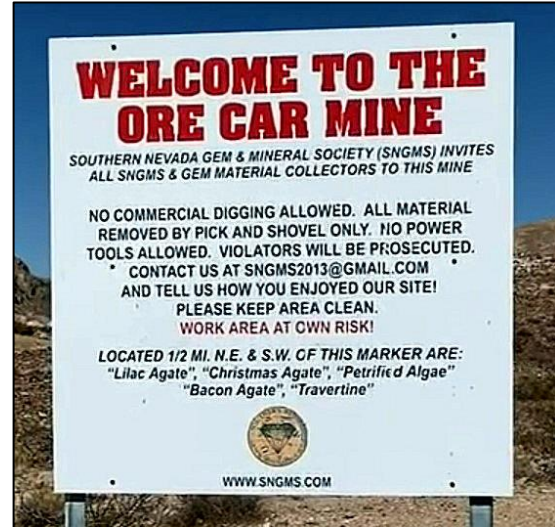

Photo Courtesy of Peggy Sue Moore

**Answers to Hidden Gems Crossword**  
(puzzle on page 5)

			4	P	E	6	A	7	R	8	L			11	G	12	O	13	S	14	H			
			18	Q				21	I	R	A	24	N		26	E	L	L	A					
31	A	Q	U	A				D			37	P	I	N	O	L	I	T		45	H			
				A			50	R			52	T	I	C			56	D	A	C	H	A		
61	T	62	U	R	Q	U	66	O	I	S	E				E			E						
75	O	A	T				79	B	X					85	J							90	B	
91	P	E	Z					Y			97	M	A	99	L	A	C	102	H	I	104	T	E	
	A										112	A	Z	E	D			A			119	O	R	
121	Z	I	R	124	C	O	126	N			128	U	S	E			132	D	133	O	R	Y		
					I			A				L								N			L	
			152	P	E	T	155	R	I	157	F	I	159	E	160	D	W	162	O	O	164	D		
				L			169	R	U	L	E		174	D	A				N			E		
181	A	A			184	I	M			187	R	O	A	M				192	Y	193	E	A	195	H
				T		199	N	O			A		M			206	E	X	I	L	E			
			212	E	M	E	R	A	L	D										N			N	



**BIRTHDAYS**

If you have an MAY birthday, Please bring something for the refreshment table at MAY’s meeting.

**APRIL BIRTHDAYS**



*Sunday Ajayi, Richard Ameral, Sophia Aragon, Barbara Belcher, Teddi Bruce, Evonne Burris, Eric Cifani, Sydney Davis, Glenda Deveaux, Michael Donahue, John Dvorak, Alejandra Elias-Jimenez, Jason Fabbi, Yenchi Haduong, Glenn Hale, William T.D. Hale Jr., John Wayne Harrington, Roy Hollowell, Ellen Jaicks, DiAnn Lawson, April Locke, Jaxon Louie, Treena Luchetta, Ruben Martinez, Lizette McCarthy, Nicole Moe, Edward Morken, Luke Pattison, Heather Perkins, Justin Ray, Wendy Robinett, Mustafa Sayed, Lorrilee Stackhouse, Trev Stinnett, Mitchell R. Stoker, Leslie Sturek, Nancy Tatom, Scott Vaughn, Susan Vermillion, James Wendel*

**WELCOME NEW MEMBERS!**

Welcome to members who recently/rejoined SNGMS. We look forward to getting to know you better.

*Christiane Arends, Mary Ashcraft, Brayden Beatty, Addison Beatty, Linda Beatty, Reginald Beatty, Shelley Britt, Jerry Buckler, Blake Cardinal, Sherri Cassel, Jordan Cassel, Lisa Crispin, Dawn Gonzalez, John Hodgson, Kell Hymer, Deb Iglesias, Joe Iglesias, Katie Matteson, Sean Matteson, Robert Meagher, Daniel Moe, Nicole Moe, Jack Pattison, Luke Pattison, Jason Pattison, Stephanie Pattison, Jonnae Pernermon, Ysidro Rodriguez, Ricky Ruff, Jahtavia Sipes, Dave Spaulding, Justen Sudberry, Zechariah Sudberry, Mary Tarifa, L.D. Tripp, Gwynn Trousdale, Rick Trousdale, Andrew Waller, James Wendel*



**SNGMS GEM & MINERAL SHOW**

**FREE ADMISSION**

Saturday May 6, 2023, 9 am –5 pm  
Sunday May 7, 2023 9 am – 4 pm  
Parks & Recreation Gym  
900 Arizona St., Boulder City, NV



**Event includes:**

- Rock and Mineral Displays
- Gems, Jewelry & Crafts Sale
- Great Activities for Kids
- Dinosaur Pics & Selfies
- Great Demonstrations
- Geode Cutting

[www.springjamboree.com](http://www.springjamboree.com)  
[www.sngms.org](http://www.sngms.org)



Scan for Directions



**See You There!**



## SNGMS Rock Stars Kids Club 2023 Field Trips and Meetings<sup>1</sup>

Field Trip/Meeting	Date	Location
Eldorado Canyon Gold Mine Tour, Gold Panning & Prospecting Merit Badge 12.5 & 12.6 <sup>2</sup> – <b>RSVP required by April 22, Limited to 40 people</b>	April 29, 2023 9:30 am – 2 pm	Eldorado Canyon Mine Tours, 16880 NV-165, Nelson, NV 89046
<b>Mother's Day – No Meeting</b>	May 14, 2023	
Ore Car Mine Field Trip, Gold Panning & Prospecting Merit Badge 12.7 & BBQ <sup>2</sup> - <b>RSVP required by May 12</b>	May 20, 2023 9 am – 2 pm	SNGMS Ore Car Mining Claim, Mile Marker 16 off of North Shore Road at Lake Mead National Recreation Area
Rock Stars Kid's Club Meeting, Field Trips Merit Badge 8.1 & 8.2	June 11, 2023, 3- 5 pm	SNGMS Lapidary Shop, 3111 South Valley View Blvd, Building E Suite 125, Las Vegas, NV 89102
Rock Stars Kid's Club Meeting, Field Trips Merit Badge 8.6 Wild Card First Aid & Safety Class	July 9, 2023, 3 – 5 pm	SNGMS Lapidary Shop, 3111 South Valley View Blvd, Building E Suite 125, Las Vegas, NV 89102
Rock Stars Kid's Club Meeting, Gemstone Lore & Legend Merit Badge 13.5	August 13, 2023 3- 5 pm	SNGMS Lapidary Shop, 3111 South Valley View Blvd, Building E Suite 125, Las Vegas, NV 89102
Geocaching for Gems, Gemstone Lore & Legend Merit Badge 13.6	September 9, 2023 8 am – 12 pm	Wetlands Park, 7050 Wetlands Park Lane, Las Vegas, NV 89122
<b>No Meeting</b>	September 10, 2023	
Rock Stars Kid's Club Meeting, Gemstone Lore & Legend Merit Badge 13.2	October 8, 2023	SNGMS Lapidary Shop, 3111 South Valley View Blvd, Building E Suite 125, Las Vegas, NV 89102
Rock Stars Kid's Club Meeting, Gemstone Lore & Legend Merit Badge 13.3	November 12, 2023	SNGMS Lapidary Shop, 3111 South Valley View Blvd, Building E Suite 125, Las Vegas, NV 89102
<b>No Meeting – Date for Holiday Party TBD</b>	December 10, 2023	

- 1) *Field trip destinations, dates, and times are subject to change.*
- 2) **MUST RSVP to Wendy Dresser at 702-556-2748 (text or call)**

### March 2023 Rock Stars Kids Club Meeting Photo Courtesy of Dave Ford



**SNMGMS 2023 VOLUNTEER STAFF**

Contact any Director to volunteer for a position, or a Committee Chair to offer to help on their committee.

**SNMGMS 2023 BOARD OF DIRECTORS**

OFFICE	DIRECTOR	EMAIL	PHONE
President	Andrea Packo	sngmspresident@gmail.com	702-279-7679
Vice-President	Orville Wiemers	sngmsvicepresident@gmail.com	702-366-5854
Secretary	Lorrilee Stackhouse	sngmssecretary@gmail.com	702-817-5602
Treasurer	Peggy Sue Moore	sngmstreasurer@gmail.com	702-434-6072
Parliamentarian	Jack Toogood	vegasmw@hotmail.com	702-510-4192
One Year Board	Ron Mazz	zman8229@gmail.com	586-914-4130
Two Year Board	Del Walkenshaw	desertartsupply@aol.com	702-451-8040
Three Year Board	Bob Belcher	f35fighterman@yahoo.com	702-210-9612
Past President	Lloyd Chayette	chayette.lloyd@yahoo.com	714-474-6384

**SNMGMS 2023 COMMITTEE CHAIRS**

COMMITTEE	CHAIR	EMAIL	PHONE
Communication	Del Walkenshaw	sngmsnews@gmail.com	702-451-8040
Rocky Mountain Federation of Mineralogical Societies	Sheri Johnson		
Alt Federation	Mary Beth Paladino		702-255-1647
Facebook Master	Dale Bright	dalebright1@hotmail.com	
Field Trip	Joel Coombs & Bill Kogan	sngmsnews@gmail.com	
Shop Foreman	Andrea Kincannon	andrea.kincannon@gmail.com	
General Meeting Greeter	Dave Ford		
Historian	Dale Bright	dalebright1@hotmail.com	
Hospitality	Open		
Inventory	Ron Mazz	zman8229@gmail.com	586-914-4130
Librarian	Mario Luchetta		
Membership	Claudia Crouse	ccrouse295@gmail.com	
Newsletter	Mary Savage	lasvegassilversmithing@protonmail.com	
New Member Liaison	Joann Sprott		
Program (Speakers)	Romy Umholtz	lucky1amr@hotmail.com	
Publicity	Andrea Packo	sngmspresident@gmail.com	702-279-7679
Raffle/Lottery	Ron Mazz	zman8229@gmail.com	586-914-4130
Refreshments	Fran & Allen Stratton		
Rock Stars	Wendy Dresser	wndresser@gmail.com	702-556-2748
Scholarship	Debbie Bucknam		
Spring Jamboree Show	Sara Schiller	sngmsjam@gmail.com	
Sunshine	Beth Jones	punkyjones@hotmail.com	702-505-5819
Webmaster	Lorrilee Stackhouse	lorrilee@cox.net	



### Speakers For 2023 General Meetings

(please contact Romy Umholtz lucky1amr@hotmail.com with speaker suggestions)

Date	Speaker	Topic
1-May-23	John Fish	Gemology
5-Jun-23	Harrison Brook	Drone footage from Easter Blue mine, Tonopah, Nevada
10-Jul-23	Dr. Simon Jowitt	Lithium Mining
7-Aug-23	Michelle S. French	Flood Control – Clark County Regional Flood Control District
11-Sep-23	Ary Udry	Martian Meteorites
2-Oct-23	Open	
6-Nov-23	SNGMS Elections – no speaker	
Dec-23	No general meeting	

### SNGMS CORPORATE SPONSORS





**DESERT  
ART  
SUPPLIES**

*“Southern Nevada’s Complete Art Store”*  
*Fine Arts Supplies – Custom Framing*

2003 E. Charleston                      2750 N. Green Valley Pkwy  
 Las Vegas, NV 89104                      Henderson, NV 89014  
 (702) 382-5404 • Fax 384-3337              (702) 451-8040 • Fax 451-8339

Toll Free 1-888-725-4666 • [www.desertartsupplies.com](http://www.desertartsupplies.com)  
[desertartsupply@aol.com](mailto:desertartsupply@aol.com)

### HI-TECH DIAMOND DISCOUNT

Hi-Tech Diamond is an online seller of capping supplies and equipment. They offer a 10% discount to SNGMS members, friends, and families on everything EXCEPT machines, gift cards, and repairs. The discount is applied when you enter the discount code **SNGMS** at checkout. The code must be manually entered at checkout, it is NOT an automatic discount! The Hi-Tech website is [www.hitechdiamond.com](http://www.hitechdiamond.com).



## Mineral Musings

### A Brief History of Lapidary

Lapidary is the art of shaping stone, minerals, or gemstones into cabochons, engraved gems (like cameos), and faceted designs. But how was this done before electric motors and modern abrasives?

#### Early Lapidary Arts

The earliest known lapidary is from 4,000 - 2,000 BCE. Jewelry was made from stones with drilled holes. Bruting was used shape stones. Bruting is done by rubbing a soft stone against another harder stone.



Neolithic stone beads

#### Start of Modern Lapidary

Until the 1400s, stones were cut with an abrasive surface or a hammer and chisel. Then, the scaif, a horizontal polishing wheel, was developed in Holland. A mixture of olive oil and diamond dust was sprinkled onto a rotating wheel made of copper, tin, or lead. The scaif made it possible to polish a gemstone symmetrically at angles that best reflected the light.

In 1609, the Dutch began using emery, sapphire, and ruby as abrasives to cut stones instead of diamond dust. It took longer to cut stones with these materials compared to diamond dust, but the abrasives were less expensive and more available.

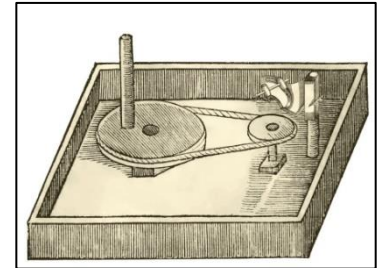

Lap Wheel from 1609.

#### Revolutionary Changes

During the Industrial Revolution, new tools to cut stones were developed. By 1895, polishing was done on hand-cranked wheels made of copper, tin, pewter (a lead alloy), or sometimes wood topped with cloth or leather. The polishing agents were diamond powder, ruby powder, tripoli, putty powder, pumice or rouge, always mixed with oil or water. The grinding and polishing powders were each applied to separate grinding or buffing wheels.

#### The 1900s

By the 1930s, laps plated with diamonds made cutting stones easier. Plated laps meant gem cutters no longer had to grind diamond powder, mix it with oil, and apply it to the lap. They could just put the lap on the machine and start cutting. However, the laps wore out quickly.

In 1954 laps with diamonds sintered into the metal were patented. They were more expensive than other laps, but lasted decades. The sintered laps were too expensive for casual hobbyists, but good for industrial cutting factories. Also in 1954, General Elected created synthetic diamonds, providing abundant and cost-effective diamond powder.



Vera Krupp at Spring Mountain Ranch  
[www.springmountainranchdocs.com/history.html](http://www.springmountainranchdocs.com/history.html)

Lapidary became a popular hobby in the United States during the 1950s. The famous Vera Krupp enjoyed cutting stones. She was a German actress and the wealthy ex-wife of an arms dealer who lived on Spring Mountain Ranch near Las Vegas, Nevada. Some of her work is on display today at Spring Mountain State Park.

#### Lapidary in the 2000s

Most modern lapidary work is done using motorized equipment. Polishing is done with resin- or metal-bonded emery, silicon carbide, aluminum oxide, or diamond dust. Often, the final polish will be done with tin oxide or cerium oxide.



### April 2023 Class Schedule

Class	Instructor	Date and Time	Cost	Location	Contact
Faceting	Tom Kidwell	Saturdays 9 am - 12 pm	\$15.00 for the class plus \$5.00 for instructor fuel fund	SNGMS Lapidary Shop, 3111 S. Valley View Blvd, Bldg E Suite 125, Las Vegas, NV 89102	moorepeggysue@gmail.com for reservations
Silver Smithing	Bella Romero & Mary Savage	Fridays 12:30-3:30 pm <b>NO CLASS APRIL 7, 2023</b>	\$35	Desert Art Supplies 2750 N Green Valley Pky Suite D Henderson NV 89014	Text 702-425-0149 no later than noon on Thursday before class for reservation
Beading	Gary Webb & Sue Dobson	Monday, April 10, 5 pm	\$10	SNGMS Lapidary Shop, 3111 S. Valley View Blvd, Bldg E Suite 125, Las Vegas, NV 89102	
Cabochon Making	Beth Jones	Sunday, April 16, 3-6 pm	\$10	SNGMS Lapidary Shop, 3111 S. Valley View Blvd, Bldg E Suite 125, Las Vegas, NV 89102	punkyjones@hotmail.com 702-505-5819
Wire Wrapping	Peggy Sue Moore	Monday, April 17, 5 pm	\$10	SNGMS Lapidary Shop, 3111 S. Valley View Blvd, Bldg E Suite 125, Las Vegas, NV 89102	moorepeggysue@gmail.com
Cabochon Contouring & Shaping	Lloyd Chayette	Wednesday, April 19, 6 pm		SNGMS Lapidary Shop, 3111 S. Valley View Blvd, Bldg E Suite 125, Las Vegas, NV 89102	chayette.lloyd@yahoo.com 714-474-6384

**All class fees include a modest donation to the SNGMS. SNGMS Instructors volunteer their time and expertise to help extend the knowledge of our members.**



**Silversmithing student.  
Photo courtesy Bella Romero**



Southern Nevada Gem & Mineral Society  
 3111 S. Valley View Blvd, E-125  
 Las Vegas, NV 89102

Return Service Requested



The Southern Nevada Gem and Mineral Society is a non-profit corporation, organized to educate ourselves and the community in the science and arts related to rocks, minerals, gems, fossils, and nature in general. Fostering an understanding and appreciation of the physical world, we can use it and protect it for future generations.

<p>SNGMS Mascot: Rock Wren</p> <p>SNGMS Gemstone: Turquoise</p> <p>SNGMS Motto: Rocks-R-Us</p> <p>SNGMS Web Site: <a href="http://www.snvms.org">www.snvms.org</a></p> <p>Membership is open to anyone with an interest in: Rocks, Gems, Geology, Fossils, Lapidary Arts or Silversmithing</p> <p>Annual Dues: Individual - \$25; Family - \$35              Meetings start 6 pm on the first Monday of the month at:</p> <p>Eagles Lodge #1213              1601 E Washington              Las Vegas, NV 89101              (702) 642-1213</p> <p>No meeting is held in December. Instead we have our annual awards dinner.</p>	POLISHED SLAB ADVERTISING RATES		
	AD SIZE	SIX MONTHS RATE	12 MONTHS RATE
	<i>Business Card</i>	\$18	\$30
	<i>Quarter Page</i>	\$48	\$90
	<i>Half Page</i>	\$90	\$170
	<i>Full Page</i>	\$150	\$275

